

The HWL is a decorative all-purpose LED suitable for a variety of applications including residential, commercial and industrial spaces. Combined with front baffle, center divider and 4 position pull chain they are also great for over bed applications.

Features and Specifications:

Construction:

- One piece extruded frosted acrylic diffuser (LED Formula)
- Durable steel body formed from cold rolled steel
- Ends are die-formed for added strength

Size Options:

- Available in 2' and 4' lengths (nominal)

Listing & Ratings:

- All electrical components are U.L. listed or recognized
- All fixtures are U.L. Certified and Union made in the USA
- Meets Buy America Act (BAA), BABA Compliant

Mounting Options:

- Ceiling, wall or suspended mount

Driver:

- Universal voltage 120-277V standard
- Custom driver tuning available for specific lumen requirements
- 0-10V or Lutron dimming optional

Warranty:

- 5 years - part replacement only (see our terms & conditions page at www.lamarled.com for details)

HWL utility wall | ceiling | suspended mount









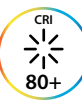

See page 2 for lumen chart, dimensions & accessories

Ordering Guide / Example		HWL48MFA-40D			
HWL			FA		
Series	Size	Power	Diffuser	CCT	General Options
HWL = Utility wall, ceiling, suspended mount	24 = 24" nominal 40 = 40" nominal 48 = 48" nominal 96 = 96" nominal	L = Low M = Medium H = High	FA = Frosted Acrylic	80 CRI 30 = 3000K 35 = 3500K 40 = 4000K 50 = 5000K 90 CRI 930 = 3000K 935 = 3500K 940 = 4000K 950 = 5000K	EM = Emergency pack >90 min., >500 lumens EMH = Emergency pack >90 min., >1400 lumens (4ft only) EMB = BABA Compliant Emergency pack >90 min., >500 lumens D = 0-10V dimming to 1% DTD = 0-10V Dim to Dark LDH = Lutron EcoSystem Hi-lume digital 1% w/Fade to Black MX1 or MX2 = 2-wire 120V or 277V 5% phase cut dimming HF = High frequency occupancy sensor on/off (internal) HFAS = User selectable 10, 20, 30 or 50% adjustable standby CD = Center divider (available with 2C wiring) 2C4PC = 2 circuit 4 position pull chain for over bed TB = Top baffle FB = Front baffle TFB = Top & front baffle TP = Tamper-proof screws

Consult factory for additional options not shown or listed
Daylight hold off function will be factory disabled on all bi-level models

Correlated Color Temperatures (CCTs) fall within the nominal range as per ANSI C78.377A

Project Information: Job Name: _____ Fixture Type: _____ Catalog #: _____ Date: _____ Comments: _____	Certification & Listings:        
---	--

BEFORE INSTALLATION, PLEASE CONSULT YOUR LOCAL ORDINANCES AND BUILDING CODES FOR COMPLIANCE

Dimensions

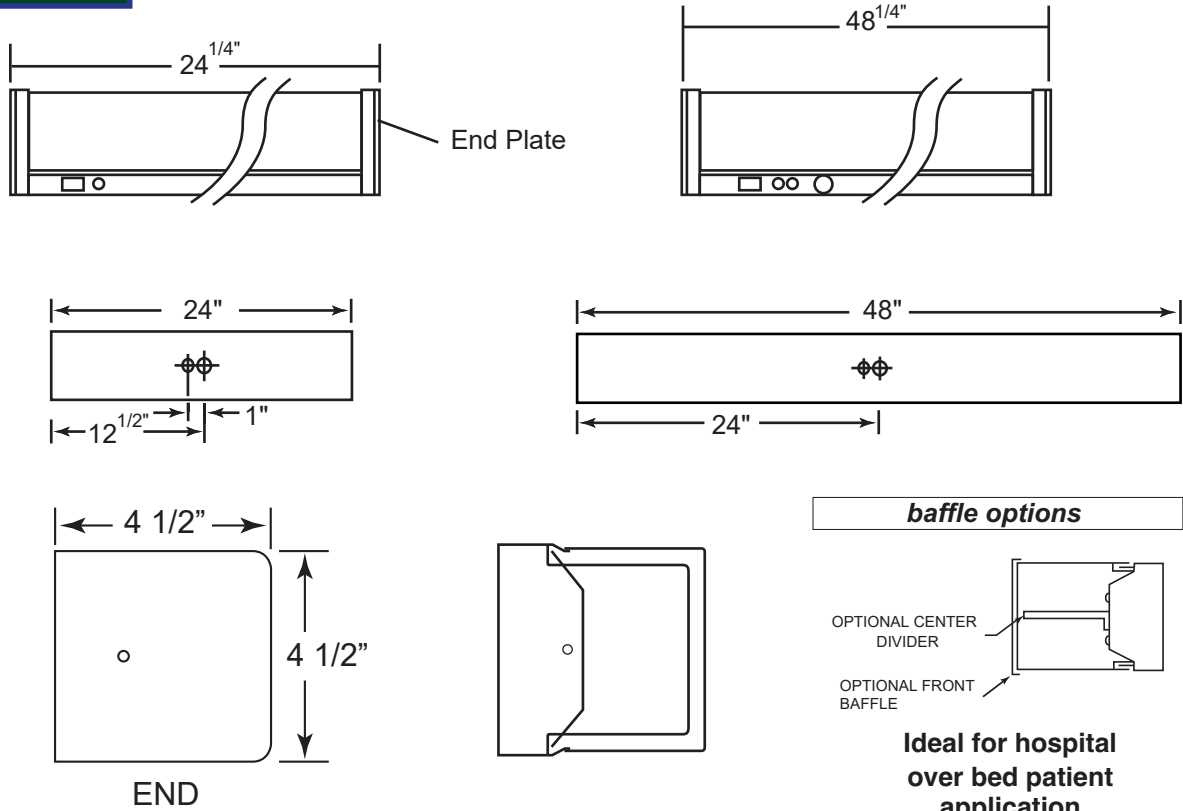

When used in draft prone areas, fixtures with high frequency sensors should be rigidly mounted

Accessories

Accessories (order separately)

Cord options available - consult factory

Lumen/Wattage Chart - 4000K

	2'	4'							
Low	12W / 1320lu	24W / 2630lu	Lumen Multipliers <table border="1"> <tr> <td>3000K</td> <td>.952</td> </tr> <tr> <td>3500K</td> <td>.968</td> </tr> <tr> <td>5000K</td> <td>1.03</td> </tr> </table>	3000K	.952	3500K	.968	5000K	1.03
3000K	.952								
3500K	.968								
5000K	1.03								
Med	16W / 1810lu	31W / 3620lu							
High	21W / 2275lu	41W / 4570lu							